

GB Translated Operating Instructions
(Also applicable for special versions)



Crane weigher Mod. TKL/TKR



Load indicator Mod. TZL/TZR



Radio remote control Mod. FFB 201

Yale Industrial Products GmbH
Postfach 10 13 24 • D-42513 Velbert, Germany
Am Lindenkamp 31 • D-42549 Velbert, Germany
Tel. 02051-600-0 • Fax 02051-600-127

Ident.-No.: 09900681/02.2010

Yale Industrial Products GmbH

INTRODUCTION

All users must read these operating instructions carefully prior to the initial operation. These instructions are intended to acquaint the user with the weighing system and enable him to use it to the full extent of its intended capabilities.

The operating instructions contain important information on how to operate the weighing system in a safe, correct and economic way. Acting in accordance with these instructions helps to avoid dangers, repair cost and downtimes and to increase the product's reliability. These instructions must always be available at the place where the weighing system is operated. Apart from the operating instructions and the accident prevention act valid for the respective country and area where the product is used, also the commonly accepted regulations for safe and professional work must be adhered to.

CORRECT OPERATION

- TKL and TKR weighing systems are compact measuring devices for the weighing of loads on hoists. They can be attached between the hook of the hoist and the load to be lifted by using components of quality grade 8.

The weighing systems have a liquid crystal display (LCD). It optionally displays the applied load as a gross or net value of the current load or of the max. value. In addition, it also indicates an overload (110 % of the rated gross load) as well as the remaining battery capacity.

- The capacity indicated on the unit is the maximum working load limit (WLL) that may be attached.
- For the weighing process, the two suspension points of the weighing system must be within a vertical line over the centre of gravity (S) of the load.
- Do not allow personnel to stay or pass under a suspended load.
- After lifting, a load must not be left unattended for a longer period of time.
- The operator may only start moving the load after it has been attached correctly and all personnel are clear of the danger zone.
- The operator must ensure that the load is attached in a manner that makes it possible to operate the hoist without exposing himself or other personnel to danger by the unit itself, the load supporting device or the load.
- The unit can be operated in ambient temperatures between -10°C and +50°C. Consult the manufacturer in case of extreme working conditions.
- In case of functional defects stop using the weighing system immediately.

Note: Operation is only allowed, if an anti-twist swivel is provided in the loaded fall. For application of the crane weighers, the definitions of the employers' liability insurance company's regulations must be observed. BGV D6 regulations apply.

INCORRECT OPERATION

- Do not exceed the rated capacity (WLL) of the unit.
- The weighing system must not be used for dynamic weighing processes.
- Shocks, torsion and sway of any kind must be avoided.
- It is forbidden to use the weighing system for the transportation of loads.
- It is forbidden to use the unit for the transportation of persons.
- The weighing system must not be changed in its design.
- Any changes to the calibration of the crane weighers are prohibited.
- The weighing system must not be used in potentially explosive zones.

INSPECTION PRIOR TO INITIAL OPERATION

Each unit must be inspected prior to initial operation by a competent person. The inspection mainly consists of a visual inspection and a function check. These inspections are intended to establish that the unit is in a safe condition and that any defects or damage are detected and eliminated, as required. Competent persons may be, for example, the maintenance engineers of the manufacturer or the supplier. However, the company may also assign performance of the inspection to its own appropriately trained specialist personnel.

INSPECTION BEFORE STARTING WORK

Before starting work, check the unit for obvious defects and faults. To do this, use the unit to lift a load over a short distance and lower it again.

INSPECTION / MAINTENANCE

Inspections should be carried out at least annually by a competent person, in the case of arduous operating conditions at shorter intervals. The inspections are mainly visual and functional and shall establish that the components of the unit are in perfect condition and do not show signs of damage, wear, corrosion or other irregularities. All safety devices are to be checked for completeness and effectiveness.

Observe the waste disposal regulations of the relevant country for the disposal of the electronic unit and/or the batteries.

Repairs may only be carried out by a specialist workshop that uses original Yale spare parts.

Inspections are instigated by the user.

FUNCTION / OPERATION

Display and keys



LCD display

2-Function key ON/OFF

2-Function key MAX

2-Function key CLEAR

LCD display of the crane weigher

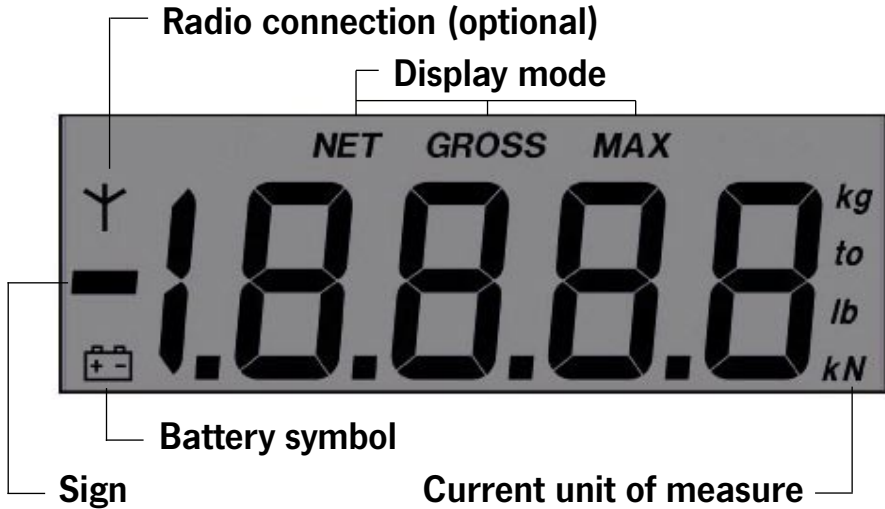

Symbols of the display

Symbol	Status	Meaning
	is lit	Radio connection ok
	is lit	Negative value
	flashes	Replace batteries soon
	is lit	Replace batteries immediately
NET	is lit	„Net Value“ display mode
GROSS	is lit	„Gross Value“ display mode
MAX	is lit	„Max. Value“ display mode
kg	is lit	Current unit of measure „kg“ (alternativ t/to/lb/kN)

Switching the crane weigher on



Actuate the ON/OFF key

Symbols of display

Meaning



Test of display



Display of rated load with unit of measure (e.g. 2.500 t)



Display of serial number



Display of battery status (e.g. 5.44 V)



Display of weighing mode

After displaying the weighing mode, the weigher is ready for operation



Function keys



Function key ON/OFF

Function key MAX

Function key CLEAR

Function key	Functions	Actuation
	<ul style="list-style-type: none"> – Switch the weigher on – Switch the weigher off – Change the unit of measure 	<p>Press briefly</p> <p>Press for 2 seconds</p> <p>Press for 0,5 seconds</p>
	<ul style="list-style-type: none"> – Change gross / net – Change from weighing mode to max. value mode 	<p>Press for 0,5 seconds</p> <p>Press for 2 seconds</p>
	<ul style="list-style-type: none"> – Set tare – Reset max. value in max. mode 	<p>Press for 0,5 seconds</p> <p>Press for 2 seconds</p>

FFB 201 radio remote control(optional)

Display and keyboard

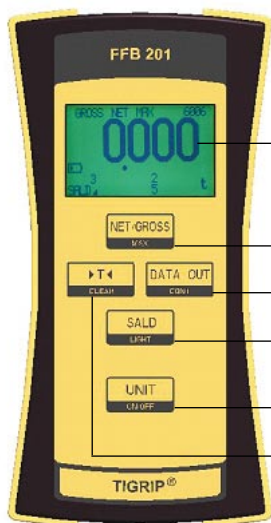

LCD display

2-Function key MAX





Function key CONT

2-Function key LIGHT







3-Function key ON/OFF

3-Function key CLEAR

Function of key



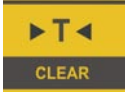

Function key	Functions	Actuation
	<ul style="list-style-type: none"> – Switch the FFB on – Switch the FFB off – Change the unit of measure 	Press briefly Press for 2 sec. Press for 0,5 sec.
	<ul style="list-style-type: none"> – Change gross / net – Change from weighing mode to max. value mode 	Press for 0,5 sec. Press for 2 sec.
	<ul style="list-style-type: none"> – Set tare – Reset max. value in max. mode 	Press for 0,5 sec. Press for 2 sec.
	<ul style="list-style-type: none"> – Send measuring value once – Send measuring values continuously 	Press for 0,5 sec. Press for 2 sec.
	<ul style="list-style-type: none"> – Accumulate (total) – Background light of the display 	Press for 0,5 sec. Press for 2 sec.

Functions of key combinations

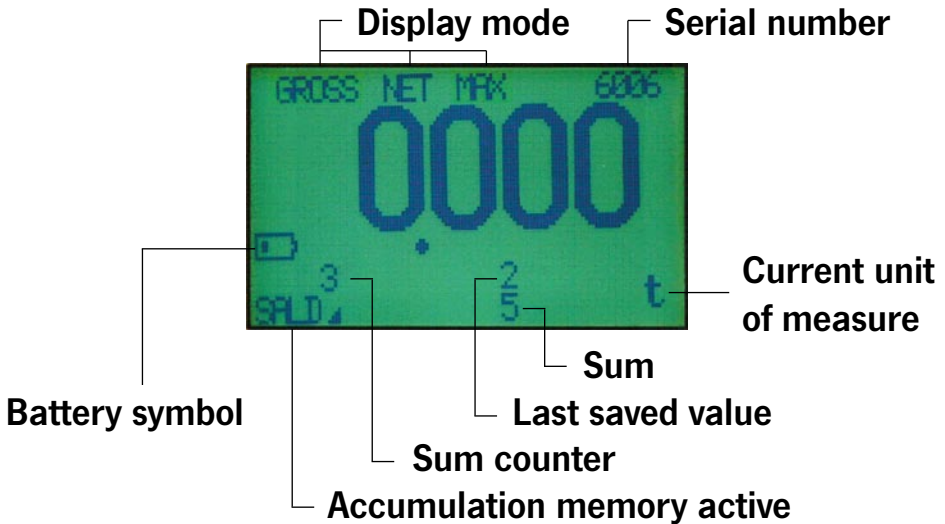
Combination keys	Functions	Actuation
 + 	Switch on accumulation memory	Hold SALD key down + press Unit key for 0,5 sec.
 + 	Switch off accumulation memory	Hold SALD key down + press Unit key for 0,5 sec.
 + 	Clear the last 5 totalled measuring values separately	Hold SALD key down + press Clear key for 0,5 sec
 + 	Clear accumulation memory (all values)	Hold SALD key down + press Clear key for 2 sec.

LCD display of the FFB



Symbol	Status	Meaning
GROSS	is lit	„Gross Value“ display mode
NET	is lit	„Net Value“ display mode
MAX	is lit	„Max. Value“ display mode
Bsp. „ 6006 “	is lit	Display of serial number
 *	is lit	4,5 - 4,3V (100 - 87%)
 *	is lit	4,29 - 4,18V (86 - 79%)
 *	is lit	4,17 - 4,04V (79 - 69%)
 *	is lit	4,03 - 3,56V (68 - 37%)
 *	flashes	3,55 - 3,00V (36 - 0%) (replace (rechargeable) battery)
SALD ▾	is lit	Accumulation (SALD) memory active [total]
E.g. „ 3 “	is lit	Display of sum counter
E.g. „ 2 “	is lit	Display of last saved value
E.g. „ 5 “	is lit	Display of sum
E.g. „ t “	is lit	Current unit of measure „t“ (alternatives: kg/to/lb/kN)

* for the use of primary cells

Replacing the (rechargeable) batteries

TKR and TZR weighing systems are supplied with commercial 4 x 1,5 V AA batteries.

The service life is approx. 200 h.

It is also possible to use 4 x 1,2 V AA (Ni-MH) rechargeable batteries. In this case, however, self-discharge of rechargeable batteries must be taken into account.

To remove the cover of the battery compartment, loosen the two recessed head screws on the rear side of the TKR and TZR unit.

The batteries can then be replaced.

Note pole arrangement for fitting the batteries!

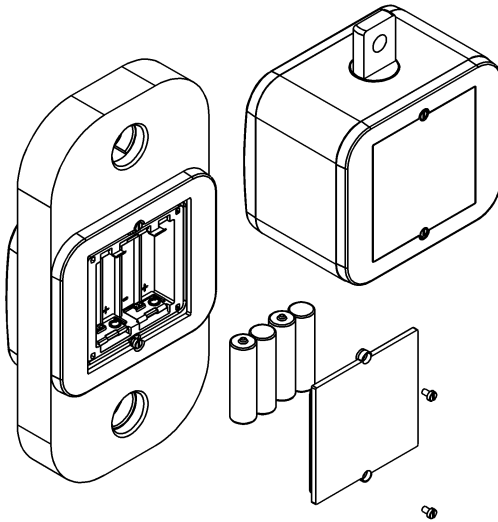

The procedure for replacing the batteries of the radio remote control system (FFB 201) is identical.

However, only 3 x 1,5 V AA batteries are required.

Spare part orders

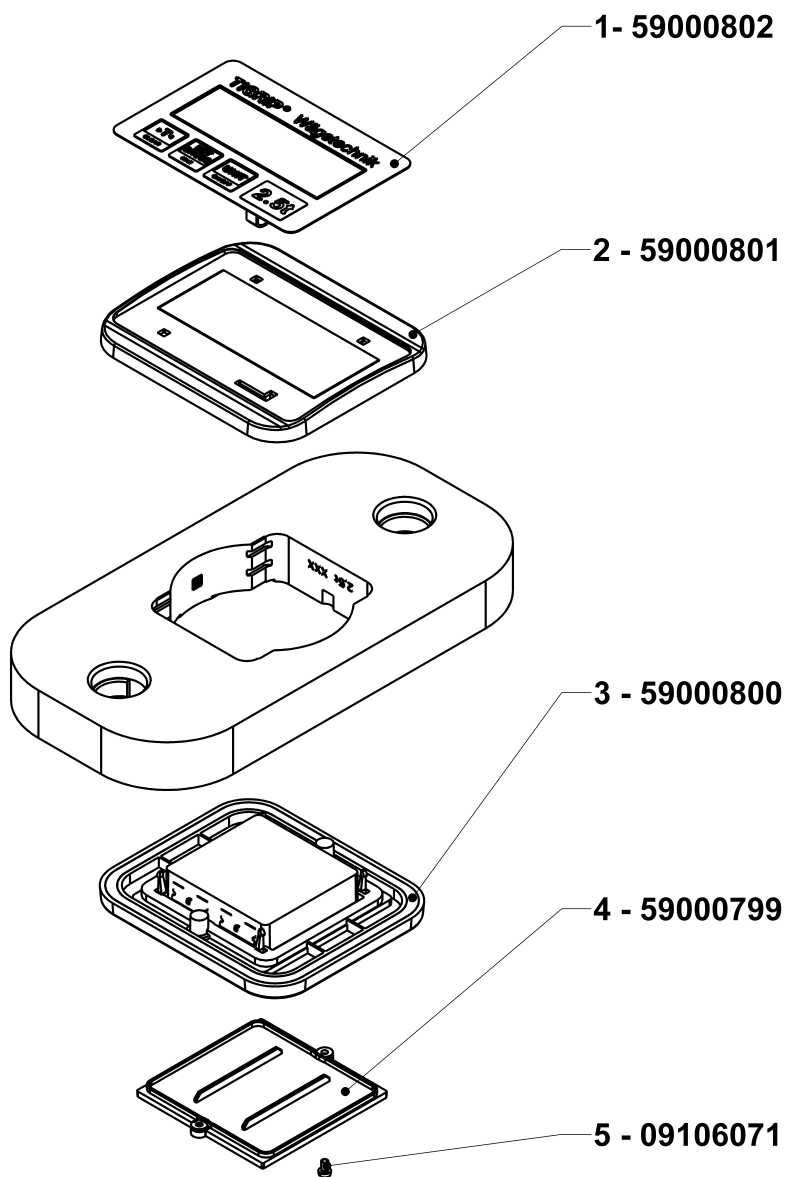

EC Declaration of Conformity 2006/42/EC (Appendix II A)

We hereby declare, that the design, construction and commercialised execution of the below mentioned products comply with the essential health and safety requirements of the EC Machinery Directive. The validity of this declaration will cease in case of any modification of or supplement to the products without our prior consent. Furthermore, validity of this EC declaration of conformity will cease in case that the products are not operated correctly and in accordance with the operating instructions and/or not inspected regularly.

Product: Load handling attachment

Type: Crane weigher TKL and TKR
TKL 1,0; TKL 2,0; TKL 3,2; TKL 5,0; TKL 8,0; TKL 12,0
TKR 1,0; TKR 2,0; TKR 3,2; TKR 5,0; TKR 8,0; TKR 12,0
Load indicator TZL and TZR
TZL 1,0; TZL 2,5; TZL 5; TZL 10; TZL 20; TZL 35; TZL 50; TZL 100
TZR 1,0; TZR 2,5; TZR 5; TZR 10; TZR 20; TZR 35; TZR 50; TZR 100

Capacity: 1,0 – 100 t

Serial no.: from manufacturing year 11/08
(serial numbers for the individual models and/or capacities are registered in the production book)

Relevant EC Directives: EC Machinery Directive 2006/42/EC

Transposed standards in particular: ISO 12100-1:2004; ISO 12100-2:2004; EN 349:2008+A1; BGR 500

Quality assurance: DIN EN ISO 9001:2000

Date / Manufacturer's signature

2010-02-10



Dipl.-Ing. Andreas Oelmann

Identification of the signee

Manager Quality Assurance

Germany and Export territories

-European Headquarters-

Yale Industrial Products GmbH

Am Lindenkamp 31
42549 Velbert
Phone: 00 49(0)2051 / 600-0
Fax: 00 49(0)2051 / 600-127
Web Site: www.yale.de
E-mail: central@yale.de

Austria

Yale Industrial Products GmbH

Gewerbepark, Wiener Straße 132a
2511 Pfaffstätten
Phone: 00 43(0)2252/ 4 6066-0
Fax: 00 43(0)2252/ 4 6066-22
Web Site: www.yale.at
E-mail: zentrale@yale.at

Netherlands

Yale Industrial Products B.V.

Grotenoord 30
3341 LT Hendrik Ido Ambacht
Phone: 00 31(0)78 / 6 825967
Fax: 00 31 (0) 78 / 6 825974
Web Site: www.yaletakels.nl
E-mail: information@yaletakels.nl

Hungary

Columbus McKinnon Hungary Kft.

8000 Székesfehérvár
Vásárhelyi út 5
Phone: 00 36(22)546-720
Fax: 00 36(22)546-721
Web Site: www.yale.de
E-mail: info@yale-centraleurope.com

France

CMCO FRANCE SARL

Zone Industrielle des Forges
18108 Vierzon Cedex
Phone: 00 33(0)248 / 71 8570
Fax: 00 33(0)248 / 75 3055
Web Site: www.cmco-france.com
E-mail: centrale@cmco-france.com

United Kingdom

Yale Industrial Products

A trading division of

Columbus McKinnon Corporation Ltd.

Knutsford Way, Sealand Industrial Estate
Chester CH1 4NZ
Phone: 00 44(0) 1244 375375
Fax: 00 44(0) 1244 377403
Web Site: www.yaleproducts.com
E-mail: sales.uk@cmworks.eu

Yale Industrial Products (Northern Ireland)

A trading division of

Columbus McKinnon Corporation Ltd.

Unit 12, Loughside Industrial Park
Dargan Crescent, Belfast BT3 9JP
Phone: 00 44(0)2890771467
Fax: 00 44(0)2890771473
Web Site: www.yaleproducts.com
E-mail: sales@yaleip.co.uk

Italy

Columbus McKinnon Italia S.r.l

Via P. Picasso, 32
20025 Legnano (MI) Italy
Phone: 00 39 (0)331 / 57 6329
Fax: 0039 (0)331 / 46 8262
Web Site: www.cmworks.com
E-mail: claudio.franchi@cmco.it

Spain and Portugal

Yale Elevación Ibérica S.L.

Ctra. de la Esclusa, 21-acc. A
41011 Sevilla
Phone: 0034 (0)954 298940
Fax: 00 34 (0)954 298942
Web Site: www.yaleiberica.com
E-mail: informacion@yaleiberica.com

South Africa

Columbus McKinnon Corporation (Pty) Ltd.

P.O. Box 15557
Westmead, 3608
Phone: 00 27(0)31/7004388
Fax: 00 27(0)31/7004512
Web Site: www.cmworks.co.za
E-mail: sales@cmworks.co.za

China

Columbus McKinnon (Hangzhou) Industrial Products Co. Ltd.

Xiaoshan, Yiqiao, Zhejiang Province
Postcode 311256
Phone: 00 8657182409250
Fax: 008657182406211
Web Site: www.yale-cn.com
E-mail: may.zhang@cmworks.com

Thailand

Yale Industrial Products Asia Co. Ltd.

525 Rajuthit Road
Hat Yai, Songkhla 90110
Phone: 00 66 (0)74 252762
Fax: 0066 (0)7 4 362780
Web Site: www.yale.de
E-mail: weeraporn@yalethai.com



Certified since November 1991